

Brillouinzones

Contents

- *Brillouin Zones*
 - *Face Centered Cubic*
 - *Body Centered Cubic*
 - *Simple Cubic*
 - *Hexagonal*
 - *Rhombohedral for $2c < a^2$*
 - *Rhombohedral for $2c > a^2$*
 - *Body Centered Tetragonal $c < a$*
 - *Body Centered Tetragonal $c > a$*
 - *Simple Tetragonal*
 - *Face centered orthorhombic $1/a < (1/b + 1/c)$, $1/b < (1/c + 1/a)$ and $1/c < (1/a + 1/b)$*
 - *Face Centered Orthorhombic with $1/c^2 > (1/a^2 + 1/b^2)$*
 - *Face Centered Orthorhombic with $1/b^2 > (1/a^2 + 1/c^2)$*
 - *Face Centered Orthorhombic with $1/a^2 > (1/b^2 + 1/c^2)$*
 - *Body Centered Orthorhombic for $a > b > c$ or $a > c > b$*
 - *Body Centered Orthorhombic for $b > a > c$ or $b > c > a$*
 - *Body Centered Orthorhombic for $c > b > a$ or $c > a > b$*
 - *Base Centered Orthorhombic $a > b$*
 - *Base Centered Orthorhombic $b > a$*
 - *Simple Orthorhombic*
 - *Base Centered Monoclinic*
 - *Simple Monoclinic*
 - *Triclinic*

1 Face Centered Cubic

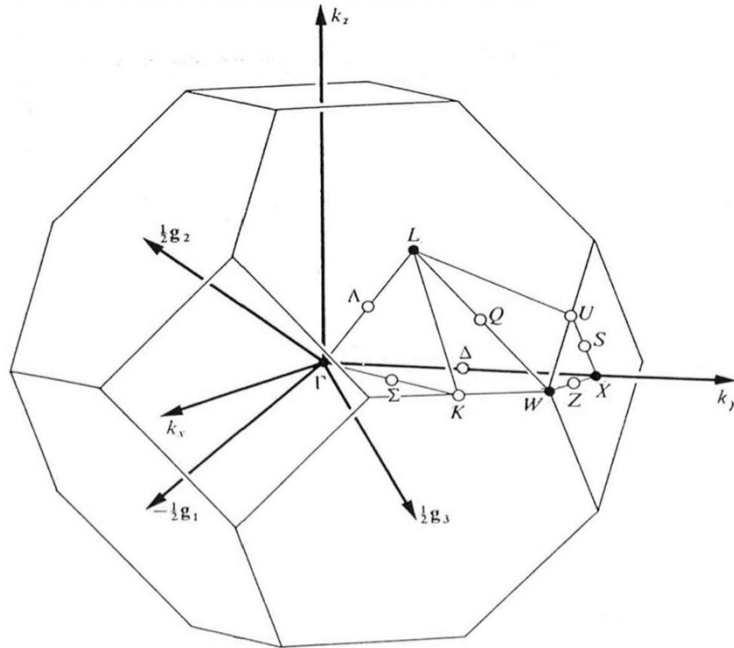
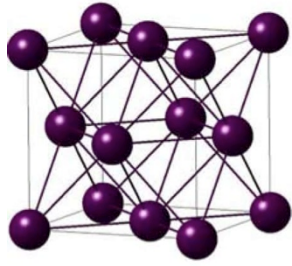

Point	$(g_1g_2g_3)$
Γ	(000)
L	$(\frac{1}{2}\frac{1}{2}\frac{1}{2})$
X	$(\frac{1}{2}0\frac{1}{2})$
W	$(\frac{1}{2}\frac{1}{2}\frac{3}{4})$
K	$(\frac{3}{8}\frac{3}{8}\frac{3}{8})$

2 Body Centered Cubic

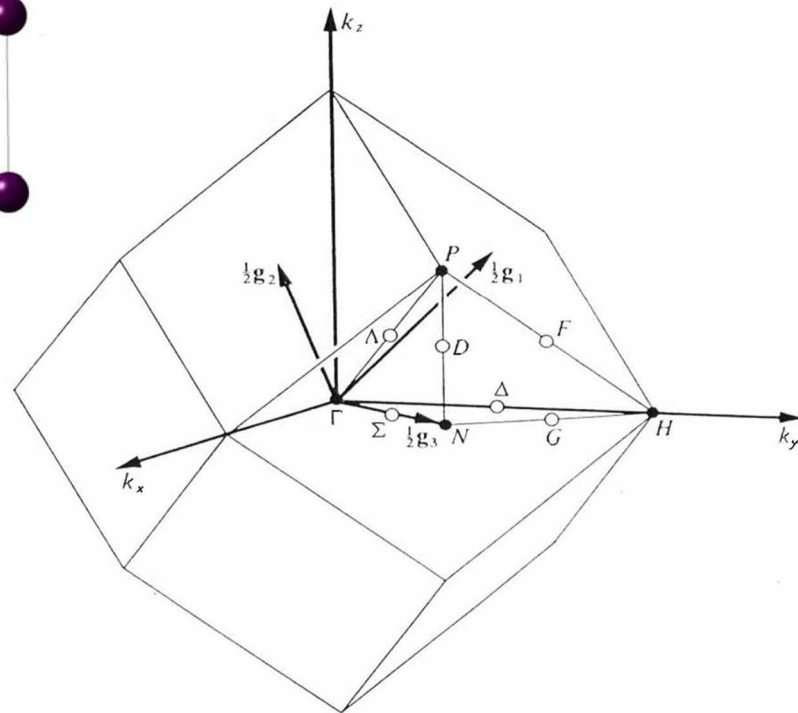
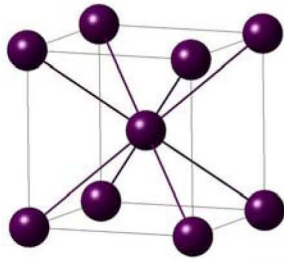

Point	$(g_1 g_2 g_3)$
Γ	(000)
H	$(\frac{1}{2} \frac{1}{2} \frac{1}{2})$
P	$(\frac{1}{3} \frac{1}{4} \frac{1}{4})$
N	$(00 \frac{1}{2})$

3 Simple Cubic

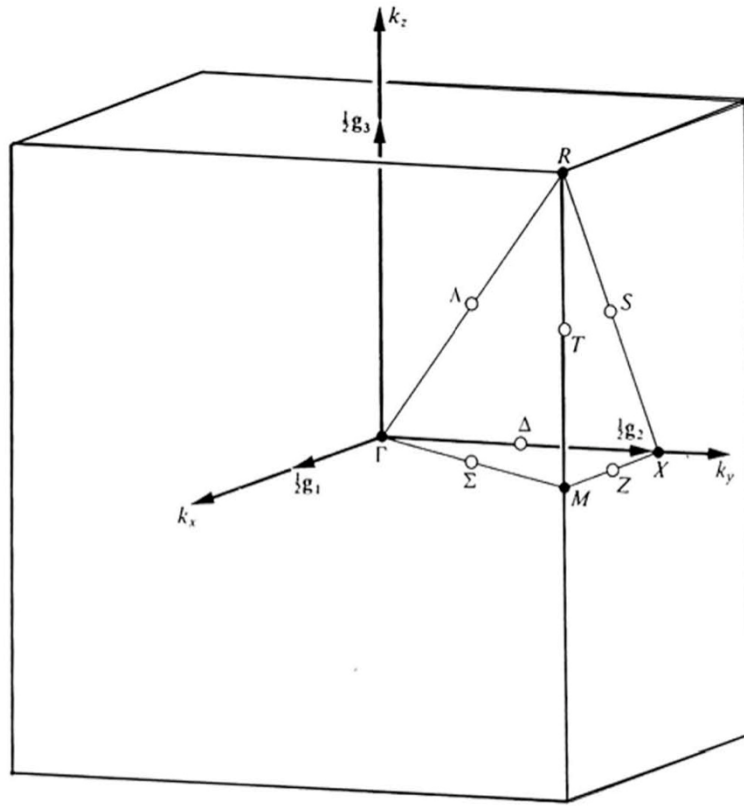
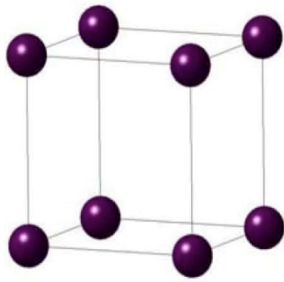

Point	$(g_1 g_2 g_3)$
Γ	(000)
X	$(0 \frac{1}{2} 0)$
M	$(\frac{1}{2} \frac{1}{2} 0)$
R	$(\frac{1}{2} \frac{1}{2} \frac{1}{2})$

4 Hexagonal

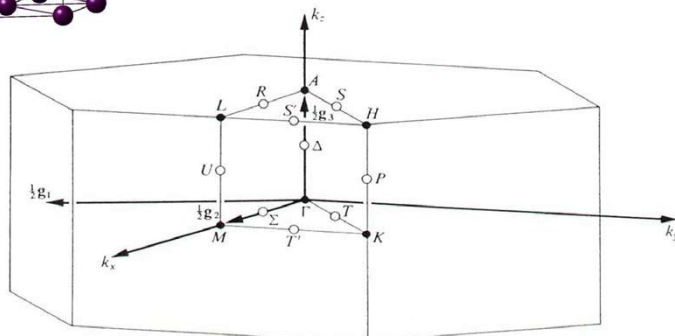
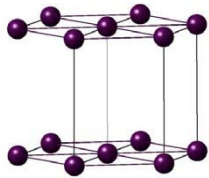

Point	$(g_1g_2g_3)$
Γ	(000)
A	$(00\frac{1}{2})$
M	$(0\frac{1}{2}0)$
L	$(0\frac{1}{2}\frac{1}{2})$
K	$(\frac{1}{3}\frac{2}{3}0)$
H	$(\frac{1}{3}\frac{2}{3}\frac{1}{2})$

5 Rhombohedral for $2c < a^2$

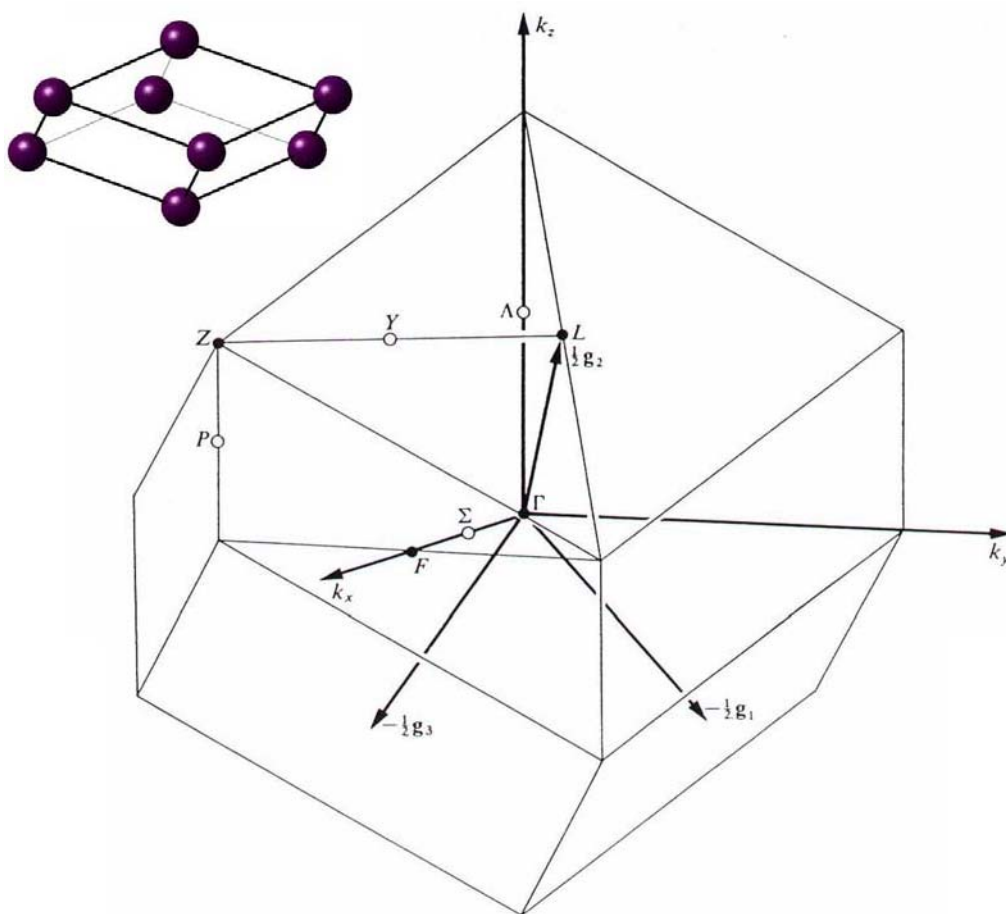

Condition $\sqrt{2c} < a$

Point	$(g_1g_2g_3)$
Γ	(000)
Z	$(\frac{1}{2}\frac{1}{2}\frac{1}{2})$
L	$(0\frac{1}{2}0)$
F	$(0\frac{1}{2}\frac{1}{2})$

6 Rhombohedral for $2c > a^2$

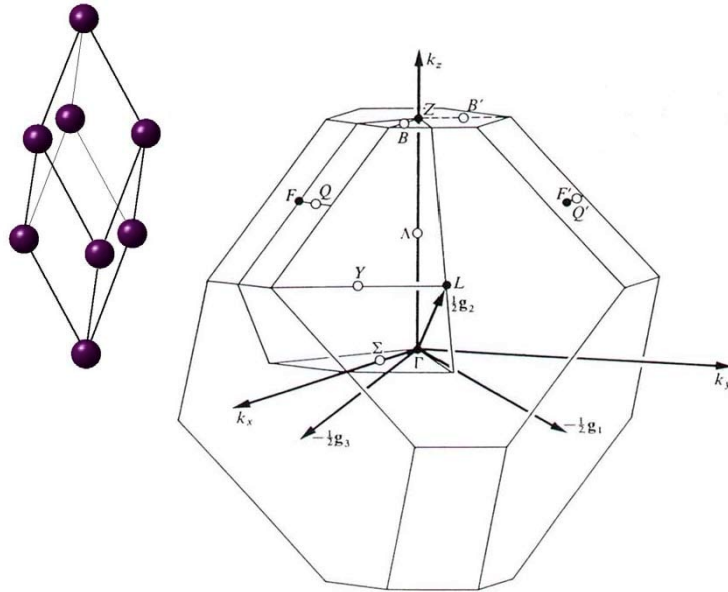

Condition $\sqrt{2c} > a$

Point	$(g_1 g_2 g_3)$
Γ	(000)
Z	$(\frac{1}{2} \frac{1}{2} \frac{1}{2})$
L	$(0 \frac{1}{2} 0)$
F	$(\frac{1}{2} \frac{1}{2} 0)$

7 Body Centered Tetragonal $c < a$

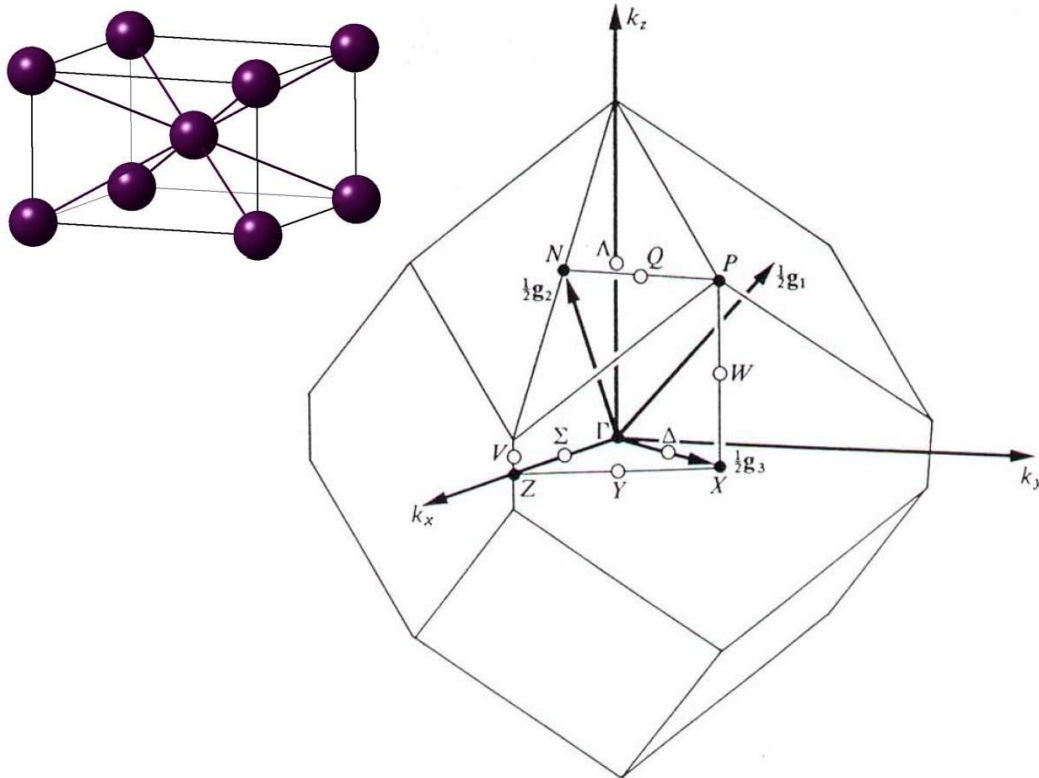

Condition $c < a$

Point	$(g_1 g_2 g_3)$
Γ	(000)
N	$(0 \frac{1}{2} 0)$
X	$(0 0 \frac{1}{2})$
Z	$(\frac{1}{2} \frac{1}{2} \frac{1}{2})$
P	$(\frac{1}{4} \frac{1}{4} \frac{1}{4})$

8 Body Centered Tetragonal $c > a$

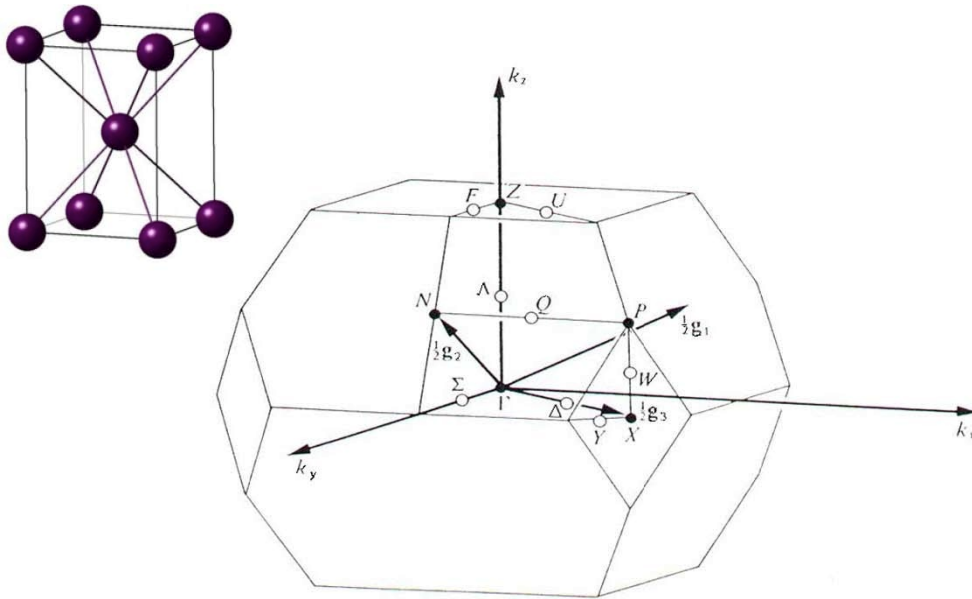

Condition $c > a$

Point	$(g_1 g_2 g_3)$
Γ	(000)
N	$(0 \frac{1}{2} 0)$
X	$(0 0 \frac{1}{2})$
Z	$(\frac{1}{2} \frac{1}{2})$
P	$(\frac{1}{4} \frac{1}{4} \frac{1}{4})$

9 Simple Tetragonal

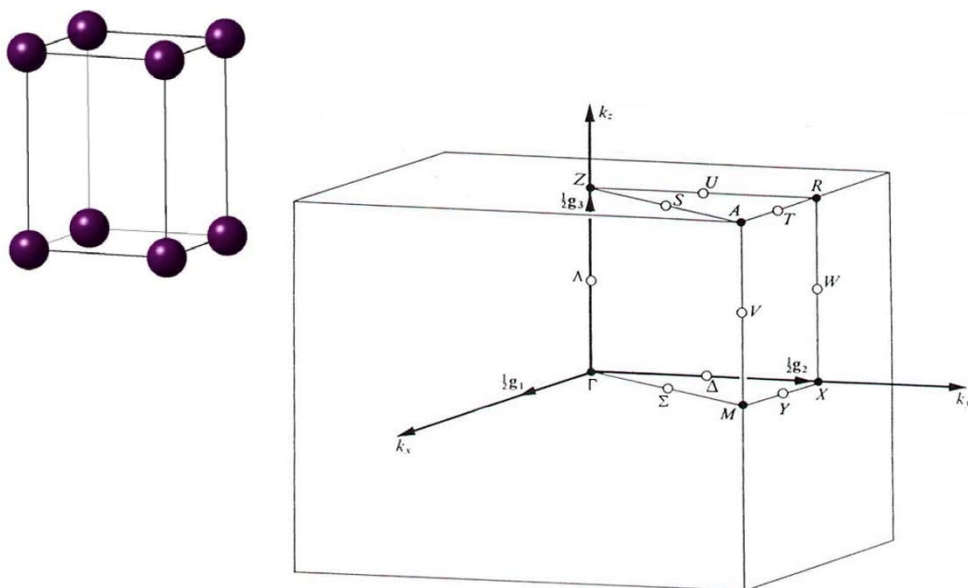

Condition $c > a$

Point	$(g_1g_2g_3)$
Γ	(000)
M	$(\frac{1}{2}\frac{1}{2}0)$
Z	$(00\frac{1}{2})$
A	$(\frac{1}{2}\frac{1}{2}\frac{1}{2})$
R	$(0\frac{1}{2}\frac{1}{2})$
X	$(0\frac{1}{2}0)$

10 Face centered orthorhombic $\frac{1}{a} < (\frac{1}{b} + \frac{1}{c})$, $\frac{1}{b} < (\frac{1}{c} + \frac{1}{a})$ and $\frac{1}{c} < (\frac{1}{a} + \frac{1}{b})$

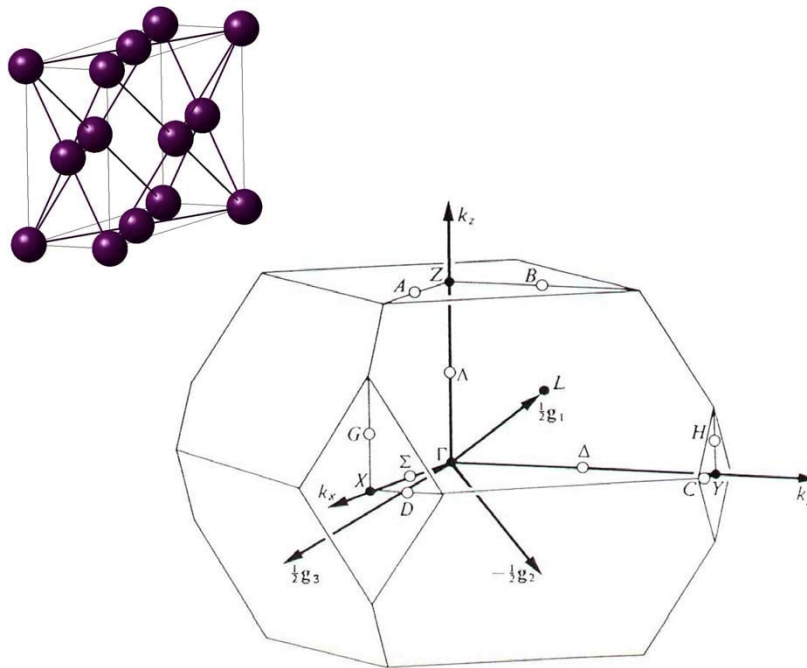

Condition $\frac{1}{a^2} < (\frac{1}{b^2} + \frac{1}{c^2}) \cap \frac{1}{b^2} < (\frac{1}{a^2} + \frac{1}{c^2}) \cap \frac{1}{c^2} < (\frac{1}{a^2} + \frac{1}{b^2})$

Point	$(g_1g_2g_3)$
Γ	(000)
Y	$(0\frac{1}{2}\frac{1}{2})$
X	$(\frac{1}{2}0\frac{1}{2})$
Z	$(\frac{1}{2}\frac{1}{2}0)$
L	$(\frac{1}{2}00)$

11 Face Centered Orthorhombic with $1/c^2 > (1/a^2 + 1/b^2)$

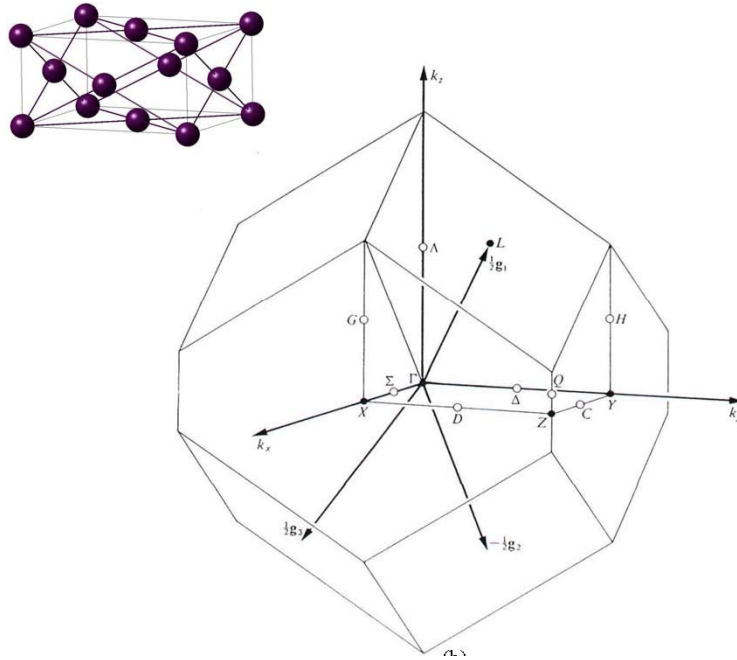

Condition $\frac{1}{c^2} < (\frac{1}{a^2} + \frac{1}{b^2})$

Point	$(g_1 g_2 g_3)$
Γ	(000)
Y	$(0 \frac{1}{2} \frac{1}{2})$
X	$(\frac{1}{2} 0 \frac{1}{2})$
Z	$(\frac{1}{2} \frac{1}{2} 0)$
L	$(\frac{1}{2} 0)$

12 Face Centered Orthorhombic with $1/b^2 > (1/a^2 + 1/c^2)$

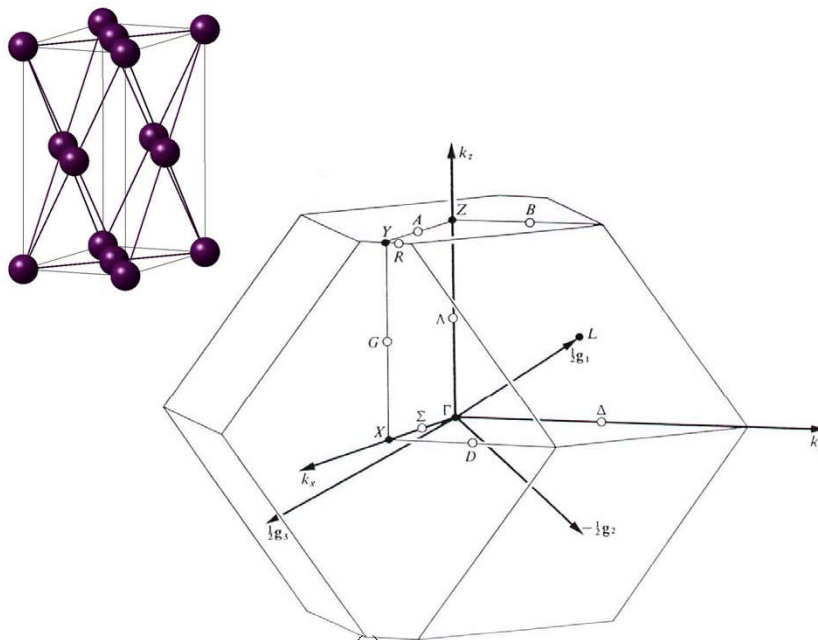

Condition $\frac{1}{b^2} < (\frac{1}{a^2} + \frac{1}{c^2})$

Point	$(g_1g_2g_3)$
Γ	(000)
Y	$(\frac{1}{2}\frac{1}{2}\frac{1}{2})$
X	$(\frac{1}{2}0\frac{1}{2})$
Z	$(\frac{1}{2}\frac{1}{2}0)$
L	$(\frac{1}{2}0)$

13 Face Centered Orthorhombic with $1/a^2 > (1/b^2+1/c^2)$

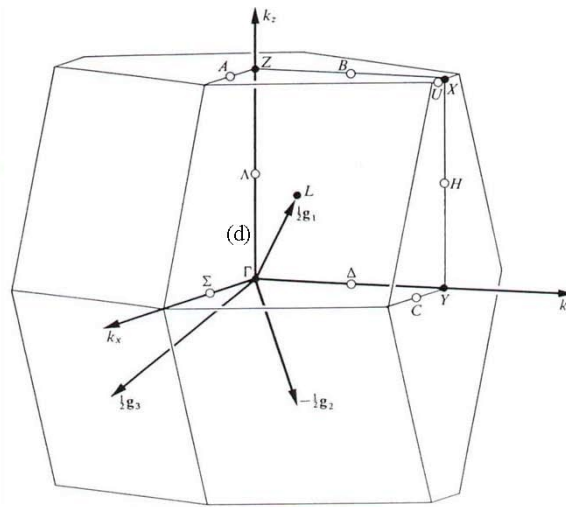
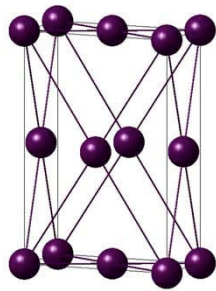

Condition $\frac{1}{a^2} < (\frac{1}{b^2} + \frac{1}{c^2})$

Point	$(g_1g_2g_3)$
Γ	(000)
Y	$(0\frac{1}{2}\frac{1}{2})$
X	$(\frac{1}{2}0\frac{1}{2})$
Z	$(\frac{1}{2}\frac{1}{2}0)$
L	$(\frac{1}{2}0)$

14 Body Centered Orthorhombic for $a > b > c$ or $a > c > b$

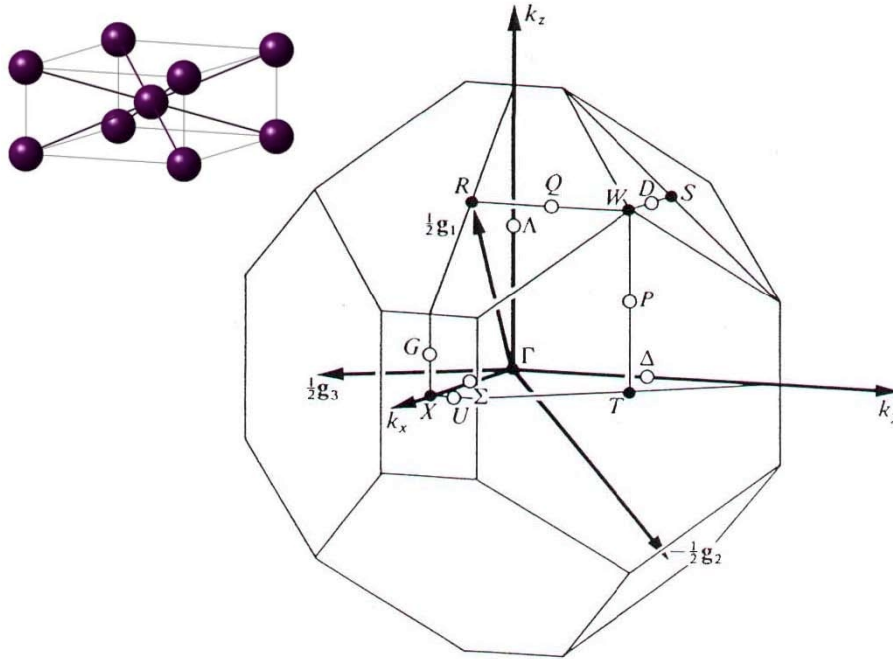

Condition $a > b > c \cup a > c > b$

Point	$(g_1 g_2 g_3)$
Γ	(0)
X	$(\frac{1}{2} \frac{1}{2} \frac{1}{2})$
R	$(\frac{1}{2} 0)$
S	$(\frac{1}{2} 0 \frac{1}{2})$
T	$(\frac{1}{2} \frac{1}{2} 0)$
W	$(\frac{3}{4} \frac{1}{4} \frac{1}{4})$

15 Body Centered Orthorhombic for $b > a > c$ or $b > c > a$

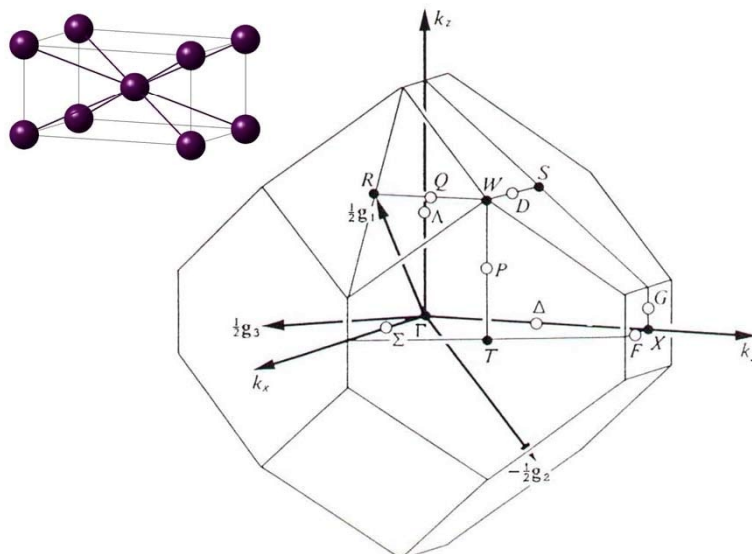

Condition $b > a > c \cup b > c > a$

Point	$(g_1 g_2 g_3)$
Γ	(000)
Y	$(\frac{1}{2} \frac{1}{2} \frac{1}{2})$
R	$(\frac{1}{2} 0 0)$
S	$(\frac{1}{2} 0 \frac{1}{2})$
T	$(\frac{1}{2} \frac{1}{2} 0)$
W	$(\frac{3}{4} \frac{1}{4} \frac{1}{4})$

16 Body Centered Orthorhombic for $c > b > a$ or $c > a > b$

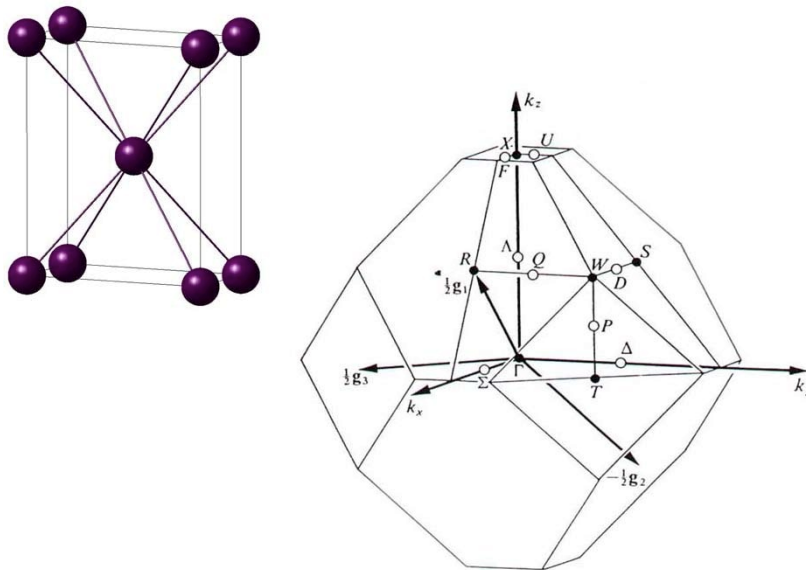

Condition $c > b > a \cup c > a > b$

Point	$(g_1 g_2 g_3)$
Γ	(000)
Y	$(\frac{1}{2} \frac{1}{2} \frac{1}{2})$
R	$(\frac{1}{2} 0 0)$
S	$(\frac{1}{2} 0 \frac{1}{2})$
T	$(\frac{1}{2} \frac{1}{2} 0)$
W	$(\frac{3}{4} \frac{1}{4} \frac{1}{4})$

17 Base Centered Orthorhombic $a > b$

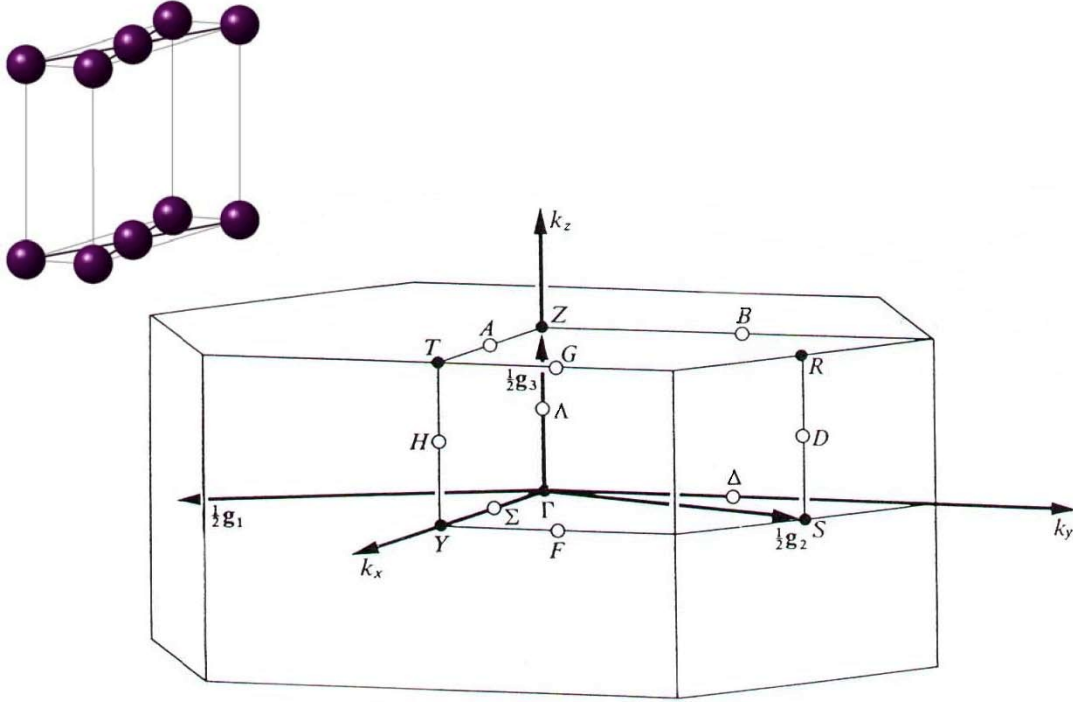

Condition $a > b$

Point	$(g_1 g_2 g_3)$
Γ	(000)
Y	$(\frac{1}{2} \frac{1}{2} 0)$
Z	$(00 \frac{1}{2})$
T	$(\frac{1}{2} \frac{1}{2} \frac{1}{2})$
S	$(0 \frac{1}{2} 0)$
R	$(0 \frac{1}{2} \frac{1}{2})$

18 Base Centered Orthorhombic $b > a$

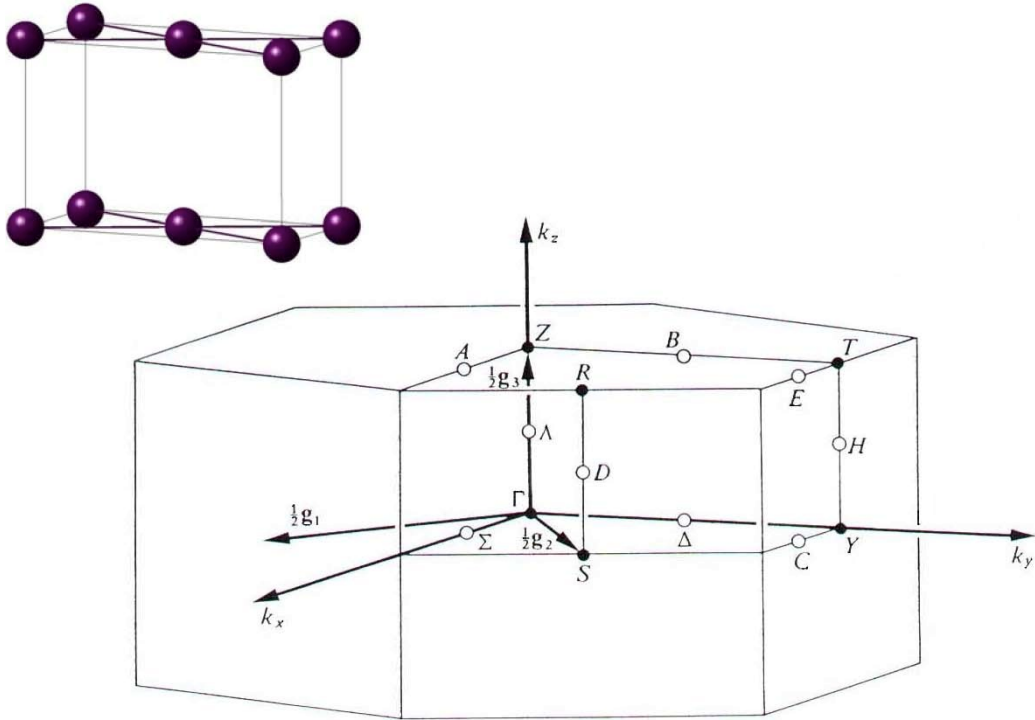

Condition $b > a$

Point	$(g_1 g_2 g_3)$
Γ	(000)
Y	$(\frac{1}{2} \frac{1}{2} 0)$
Z	$(00 \frac{1}{2})$
T	$(\frac{1}{2} \frac{1}{2} \frac{1}{2})$
S	$(0 \frac{1}{2} 0)$
R	$(0 \frac{1}{2} \frac{1}{2})$

19 Simple Orthorhombic

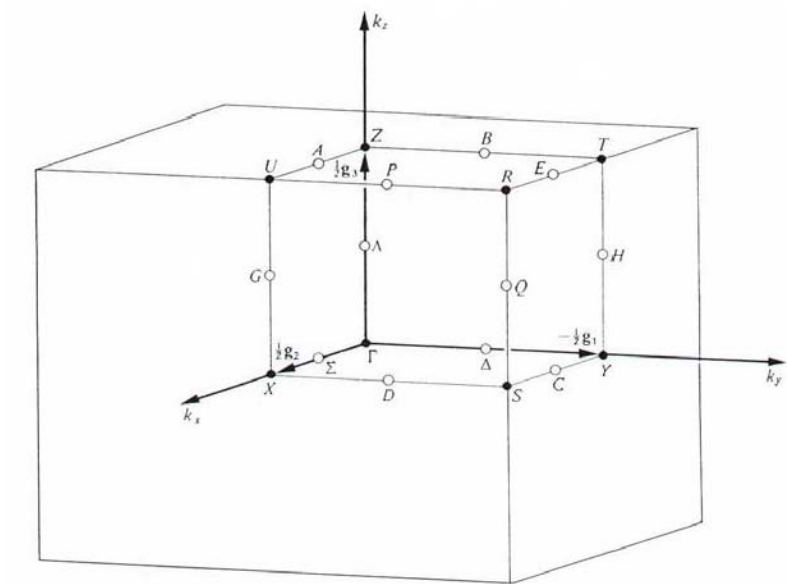
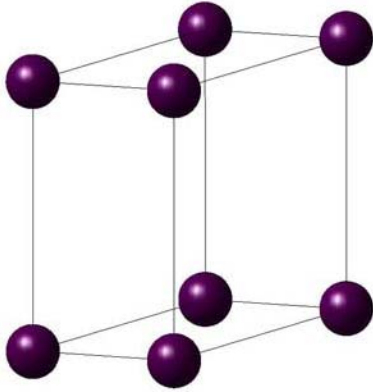

Point	$(g_1 g_2 g_3)$
Γ	(000)
Y	$(\frac{1}{2} 0 0)$
X	$(0 \frac{1}{2} 0)$
Z	$(0 0 \frac{1}{2})$
U	$(0 \frac{1}{2} \frac{1}{2})$
T	$(\frac{1}{2} 0 \frac{1}{2})$
S	$(\frac{1}{2} \frac{1}{2} 0)$
R	$(\frac{1}{2} \frac{1}{2} \frac{1}{2})$

20 Base Centered Monoclinic

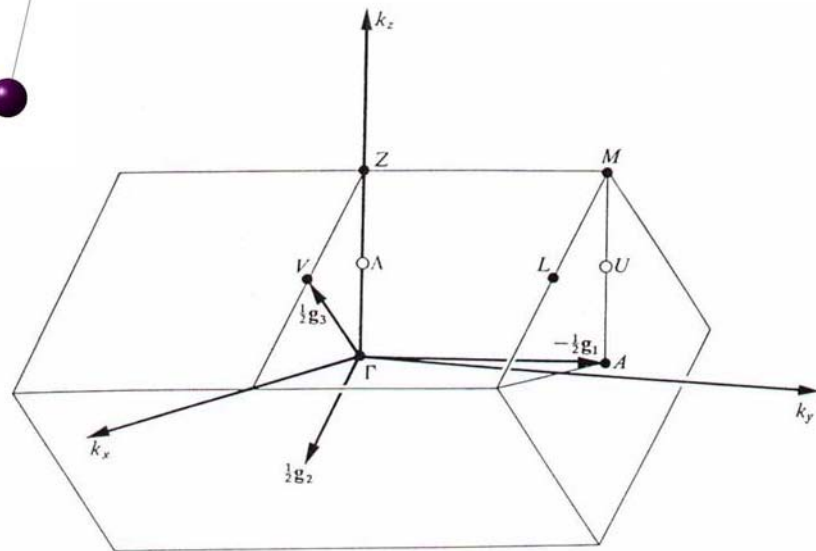
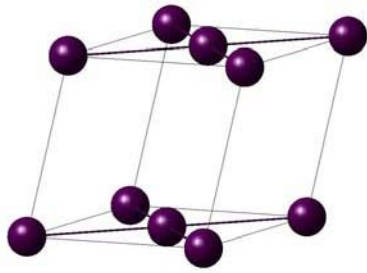

Point	$(g_1 g_2 g_3)$
Γ	(000)
A	$(\frac{1}{2} 0 0)$
Z	$(0 \frac{1}{2} \frac{1}{2})$
M	$(\frac{1}{2} \frac{1}{2} \frac{1}{2})$
L	$(\frac{1}{2} 0 \frac{1}{2})$
V	$(0 0 \frac{1}{2})$

21 Simple Monoclinic

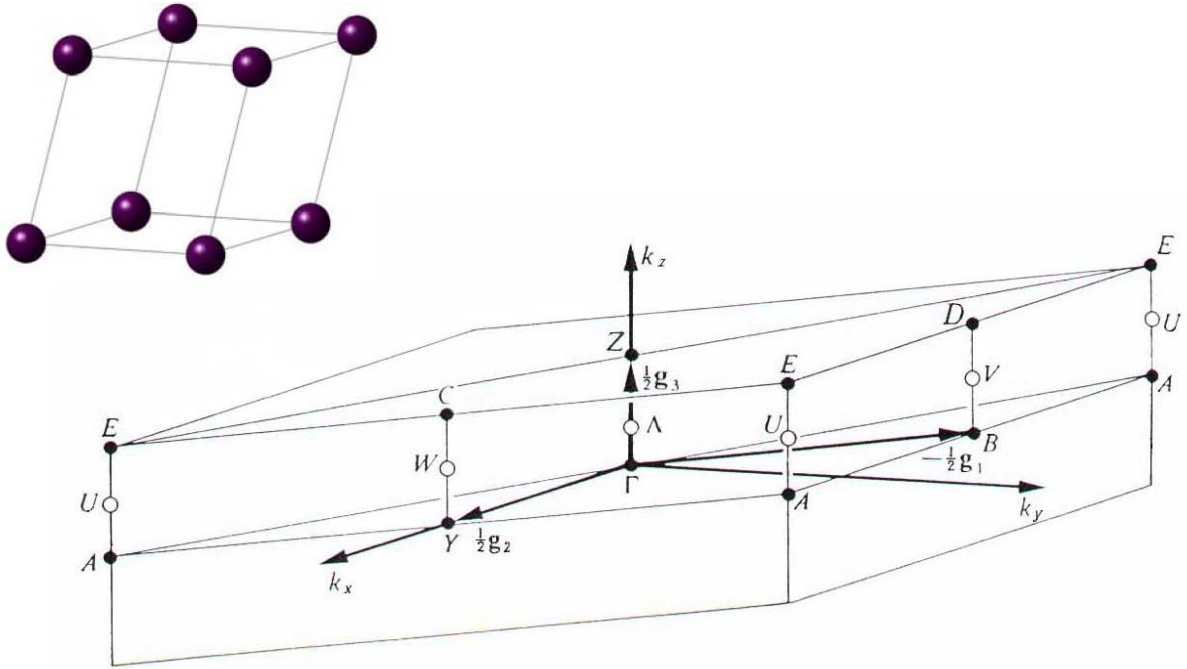

Point	$(g_1 g_2 g_3)$	as well as
Γ	(000)	
B	$(\frac{1}{2}00)$	
Y	$(0\frac{1}{2}0)$	
Z	$(00\frac{1}{2})$	
C	$(0\frac{1}{2}\frac{1}{2})$	
D	$(\frac{1}{2}\frac{1}{2})$	
A	$(\frac{1}{2}\frac{1}{2}0)$	$(\frac{1}{2}\frac{1}{2}0)$ or $(\frac{1}{2}\frac{1}{2}0)$
E	$(\frac{1}{2}\frac{1}{2}\frac{1}{2})$	$(\frac{1}{2}\frac{1}{2}\frac{1}{2})$ or $(\frac{1}{2}\frac{1}{2}\frac{1}{2})$

22 Triclinic

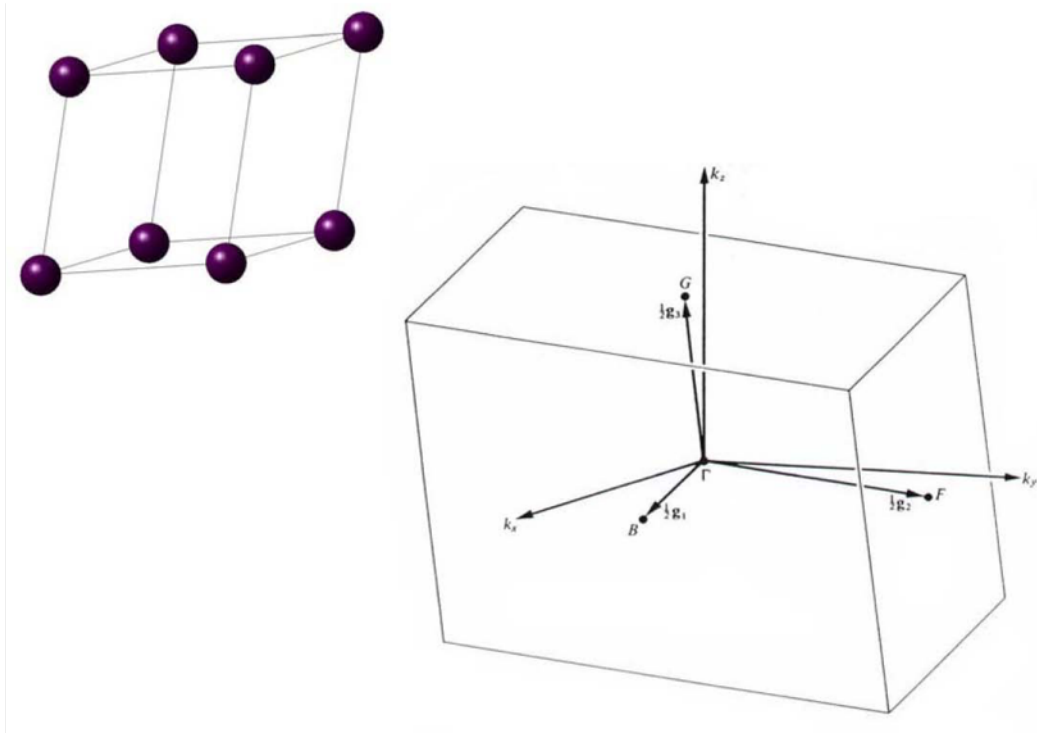

Point	$(g_1 g_2 g_3)$
Γ	(000)
B	$(\frac{1}{2} 0 0)$
F	$(0 \frac{1}{2} 0)$
G	$(0 0 \frac{1}{2})$